

RP1500: Outlet Measurement, SNMP Hardware

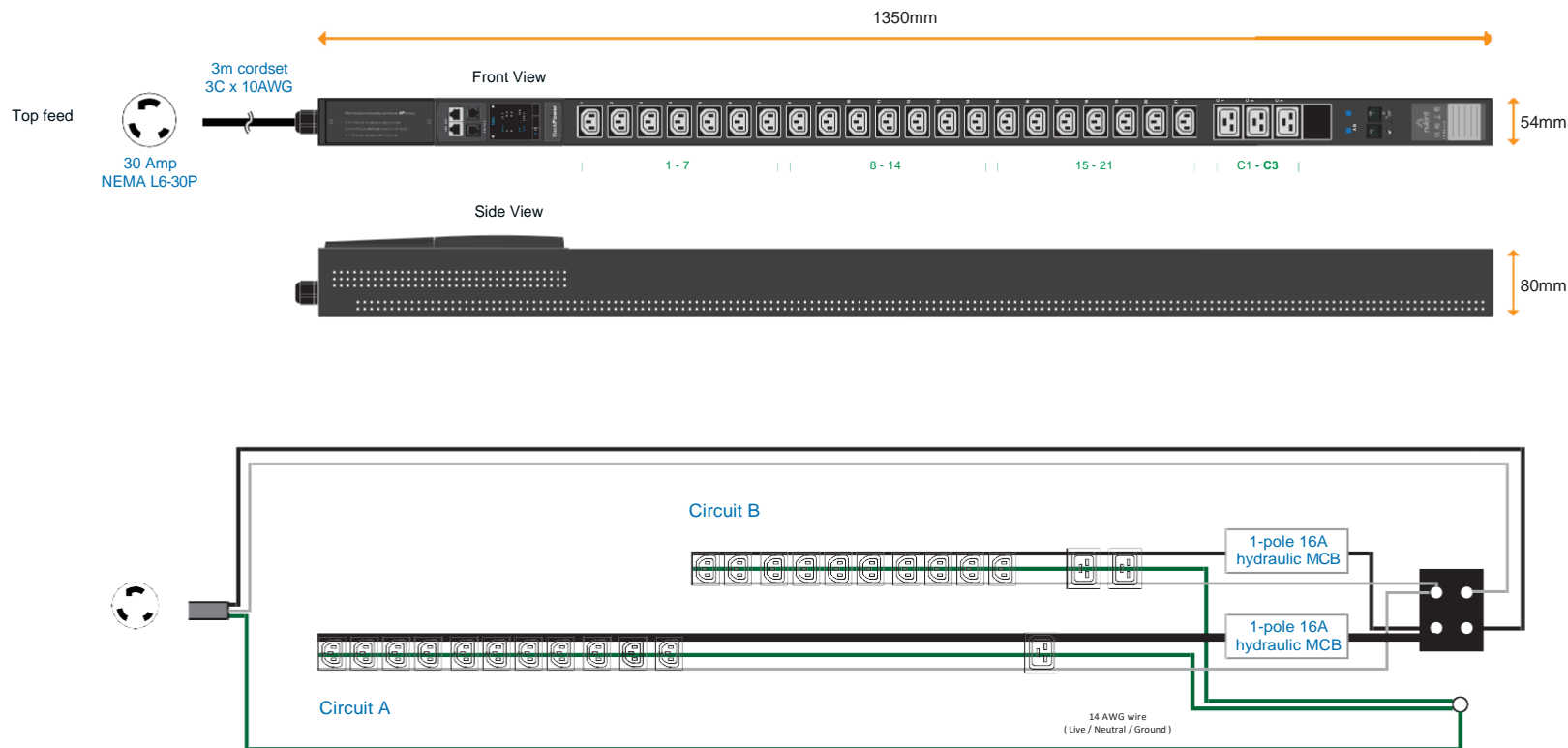

Single phase monitored + outlet measurement PDU

Input Rating : 30A, 208V
 Outlet : 10A Rated C13 x 21
 16A Rated C19 x 3
 Inlet : 30A NEMA L6-30P plug
 Cordset : 3 meter UL SJT 10AWG cordset
 Protection : 16A single pole hydraulic MCB x 2
 Circuit Details : < **Circuit A** > Output 12A max. C13 #1-11 + C19 #C1
 < **Circuit B** > Output 12A max. C13 #12-21 + C19 #C2-C3

Meter Features (Wi Monitored PDU + Outlet Measurement)



Local Display : Field replaceable 1.8" color LCD
 Bank Measurement : Current (A), Energy (kWh), Voltage (V) & Powerfactor
 Outlet Measurement : Current (A), Energy (kWh)
 Accuracy : ±1% Billing-grade
 IP Access : via IP dongle, one IP Access up to 16 PDU Levels
 Cascade : Up to 16 PDU under single IP address via IP dongle
 SNMP : V2 / V3 via IP dongle
 Sensor Port x 2 : Temp. Sensor / Temp. + Humid. Sensor

EMC Compliance : FCC Part 15 Subpart B certified
 Safety Compliance : cTUVus Mark to UL 60950-1:2007/R:2014-10
 CAN/CSA-C22.2 No. 60950-1:2007/A2:2014-10
 UL 62368-1:2014
 CAN/CSA-C22.2 No. 62368-1:2014
 Environment Compliance : UL 60730-1 Ed.5 (2016)
 : RoHS2 & REACH

Operating Temperature : -5 to 60 °C
 Storage Temperature : -25 to 65 °C
 Operating Altitude : 0 to 2,000 m
 Storage Altitude : 0 to 15,000 m
 Humidity : 8 to 95% RH, non-condensing



Chassis Material : Steel
 Chassis Color : Black
 Product Dimension : 2.1 (W) x 3.1 (D) x 53.1 (H) inch
 Net Weight : 14.5 lbs
 Packing Dimension (for 2 PDUs) : 4.3 (W) x 10.6 (D) x 80.4 (H) inch
 PDU Gross Weight (for 2 PDUs) : 37.2 lbs

VMS Mounting Button

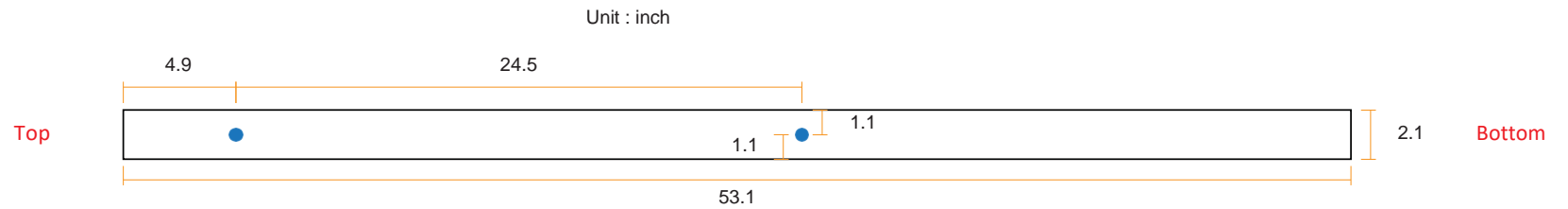
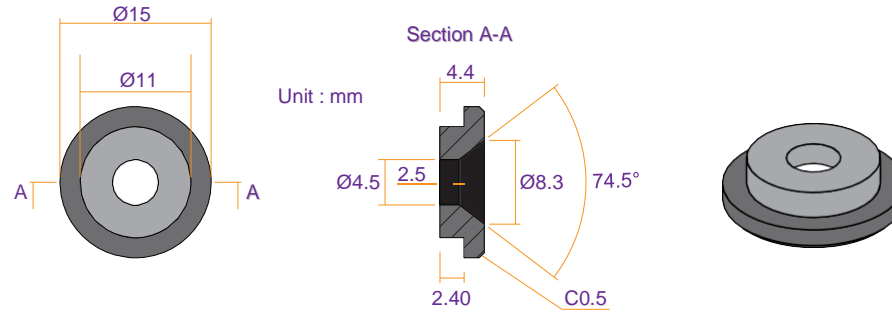
 **x 2** +  **x 2**
M4 Screw
 - Flat head
 - M4x10mm
PEG



VMB Mounting Bracket

 **x 4** +  **x 2**
M3.2 Screw
 - Flat head
 - M3.2x6mm
Bracket

