

OPERATOR ADAPTER A21SDA

Installation Instructions for Square “D” Bulletin 9422 Variable Depth and Flexible Cable Operating Mechanisms
(For parts list, see page 2)

For floor-mounted enclosures with disconnect on the right flange, see pages 3–6 (flexible cable mechanism, see pages 15–19)

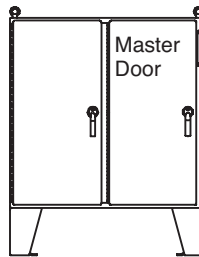

For one through six door free-standing enclosures with the disconnect on the right flange, see pages 7–10 (flexible cable mechanism, see pages 15–19)

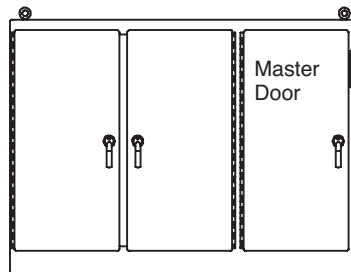

For floor-mounted enclosures with the disconnect on the centerpost, see pages 11–14 (flexible cable mechanism, see pages 15–19)

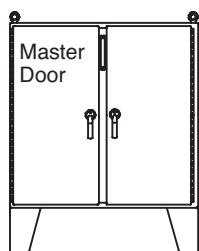

WARNING

The functions, fits, and clearances of the installation described hereon are calculated from information supplied by the manufactures of the equipment to be installed. Be certain to check the function, fits, and clearances of all equipment both before and after installation to assure that is operates properly and safely and meets all applicable codes, standards, and regulations.

In the event the completed installation does not function properly or fails to meet any such codes, standards, or regulations, do not attempt to make alterations or operate the equipment. Report such facts immediately to:

Hoffman Customer Service
2100 Hoffman Way
Anoka, MN 55303
763 422 2211
<http://hoffman.nvent.com/contact-us>

PARTS LIST

Operator Adapter, Catalog Number A21SDA, for Square "D" Bulletin 9422 Disconnects

<u>Item No.</u>	<u>Part Name</u>	<u>Part No.</u>	<u>Quantity</u>
1	Mounting Plate for Sq. D 9422	26247003	1
2	Gasket, Plate	26216011	1
3	Screw, 1/4-20x1/2 Pan HD	99401031	4
4	Slide Arm	26250001	1
5	Shoulder Collar	26149001	1
6	Screw, 1/4-20x7/8 Hex HD	99401030	1
7	Lockwasher, 1/4 Spring	99401318	1
8	Washer, Flat	22101003	2
9	Lockwasher, 1/4 Int.	99401300	2
10	Nut, 1/4-20 Hex	99401406	2
11	Door Catch	23101002	1
12	Screw, 10-32x3/8 Pan HD	99401007	2
13	Lockwasher, #10 Int	99401307	2
14	Label, (extra)	26147001	1
15	Mounting Plate for Sq. D Cable Operator	27206002	1
16	Installation Instruction	99401946	1

INTRODUCTION

This installation instruction is for Square "D" Bulletin 9422 (variable depth) mechanisms. These mechanisms are for disconnect switches and circuit breakers mounted in Hoffman two door floor-mounted, enclosures with the disconnect on the right flange.

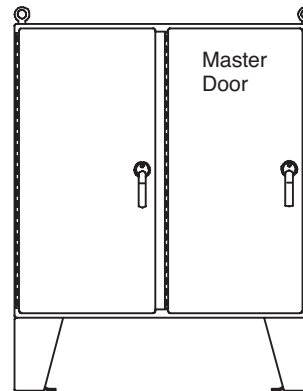

INSTALLATION STEPS

Step 1 - Install Handle return spring (furnished with Square "D" operating handle) through hole provided in mounting plate (item 1) as shown. The long hooked end of spring goes through hole in mounting plate. The short hook on other end will be attached to rod later.

Step 2 - Install mounting plate (item 1) (with spring in place) and plate gasket (item 2) on the inside of the enclosure, behind the rectangular opening provided. Secure in place with four screws (item 3).

Step 3 - Discard the Square "D" stiffener bracket which is normally installed inside the enclosure flange, behind the operating handle.

Step 4 - Assemble the Square "D" operating handle to the mounting plate which was installed in the enclosure in step 1. Omit cap screw and lockwasher which fits into bottom hole of operating handle.

Step 5 - Install the slide arm (item 4) over the projecting part of the handle assembly (on Square "D" operating handle) with notch toward door opening, as shown. Place the smaller diameter end of the shoulder collar (item 5) through the oval slot in the slide arm. Install long cap screw (item 6) with lockwasher (item 7) through shoulder collar into the bottom mounting hole of the Square "D" operating handle and tighten. The slide arm and interlock arm should move up and down smoothly. Install locking lever extension (Square "D" part) per Square "D" instructions.

Step 6 - Attach the bottom of the slide arm (item 4) to the offset arm of the lock release mechanism. Use two flat washers (item 8), two lockwashers (item 9), and two hex nuts (item 10). Do not tighten until parts are adjusted. (see step 7B)

Step 7 - The handle safety lock release mechanism is adjustable in two places.

(A) Check the adjustment of the factory installed roller bracket. The door latch should hit against the latch stop portion of the roller bracket when the door is closed and latched. Adjust up or down if necessary. The attached mechanism will then provide the necessary up-down motion required to operate the release mechanism.

(B) Adjust the length of the slide arm assembly. With proper adjustment of the slide arm, the safety lock (on Square "D" handle operator) should release just before the master door is fully latched. Lengthen slide arm if safety lock releases too soon. Shorten slide arm if safety lock releases too late.

Step 8 - Attach the door catch (item 11), provided by Hoffman, to the tapped spacer on the door using the bottom set of mounting holes. Use two screws (item 12) and lockwashers (item 13). The door catch prevents the door from being opened when the switch is in the "ON" position. The door catch may be easily bent up or down to hook properly on the locking lever extension of the Square "D" handle operator.

Step 9 - Drill and tap holes in panel as shown in diagram and table. See Square "D" instructions for locating holes for fuse clips.

Step 10 - Mount switch or circuit breaker using Square "D" instructions and parts. Square "D" operating rod (and stiffener rod, if used) must be cut off per Square "D" instructions. See table 2 for depth dimensions used to determine length of rods.

For Floor-Mounted, Two Door Enclosures With Disconnect on Right Flange

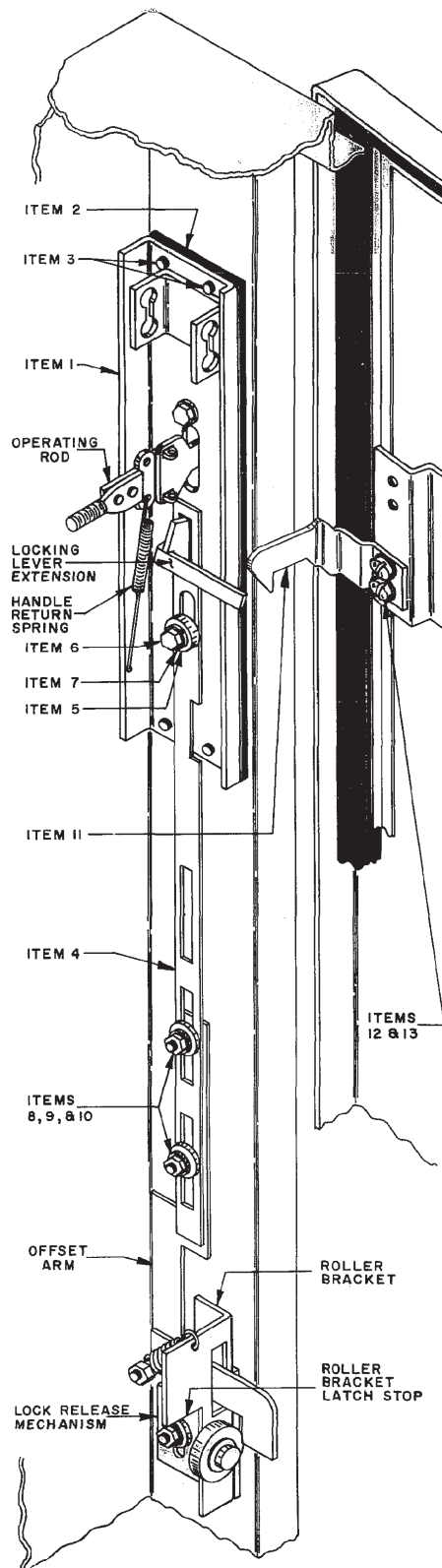

* Parts of lock release mechanism

For Floor-Mounted, Two Door Enclosures With Disconnect on Right Flange

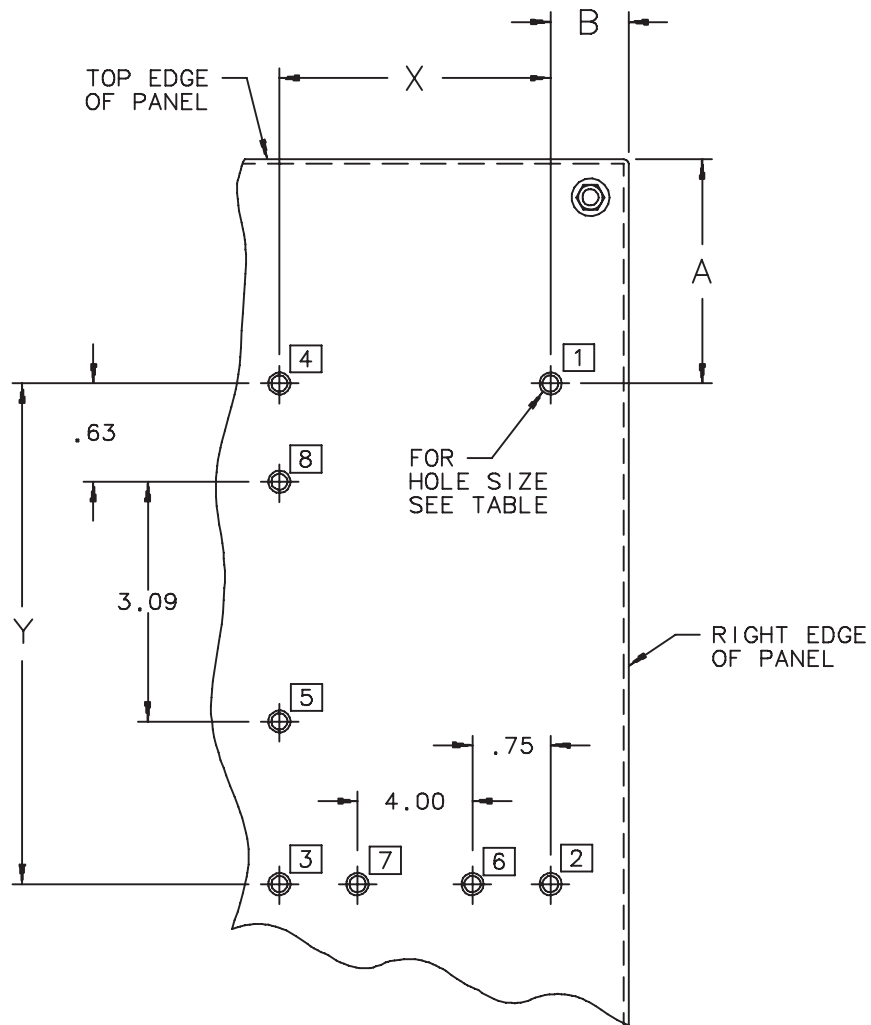

For Floor-Mounted, Two Door Enclosure With Disconnect on Right Flange

TABLE 1								
SQUARE "D" OPERATING MECHANISM	No. of Holes	Mtg. Hole Position	Mtg. Hole Size	Enclosure Height		B	X	Y
				60.12	72.12			
				A	A			
TCN, TCF	4	1,4,6,7	10-24	4.81	10.81	.50	5.50	4.50
TDN, TDF	4	1,4,6,7	10-24	4.81	10.81	.50	5.50	4.50
TEN, TEF	4	1,4,6,7	10-24	4.81	10.81	.50	5.50	4.50
TC	4	1,2,5,8	10-24	4.62	10.62	.50	5.13	6.50
TD	4	1,2,4,7	10-24	4.81	10.81	.59	5.19	5.25
TE	4	1,2,3,4	1/4-20	3.19	9.19	1.97	5.50	6.50
TF	4	1,2,3,4	5/16-18	2.56	8.56	1.44	9.44	8.00
RG1	4	1,2,3,4	8-32	4.81	10.81	1.59	1.18	3.94
RN1	4	1,2,3,4	8-32	5.34	11.34	1.50	1.50	5.13
RP1	4	1,2,3,4	10-24	5.34	11.34	1.69	1.50	7.13
RR-1	4	1,2,3,4	1/4-20	----	10.69	.31	6.63	6.56
	4	1,2,3,4	.375 Dia.	----	9.31	2.63	2.00	9.25

TABLE 2		
Hoffman Disconnect Enclosure Description	Enclosure Depth C	Square "D" D (1)
Two Door, Floor-Mounted Disconnect on Right Flange	12.13	10.63
	18.13	16.63
	24.13	22.63 (2)

1) This dimension is used to determine the length to cut off Square "D" operating rods. Use .125 for "T" dimension. See Square "D" instructions.

2) This dimension is greater than the depth range of standard Square "D" operating / stiffener rods. A six inch high platform is provided with this enclosure to reduce the depth for disconnect mounting. The platform can be eliminated if Square "D" 9422-R2 long operating rod(s) are used. Some devices require two operating rods.

INTRODUCTION

This installation instruction is for Square "D" Bulletin 9422 (variable depth) mechanisms. These mechanisms are for disconnect switches and circuit breakers mounted in Hoffman one through six door, free-standing enclosures with the disconnect on the right flange.

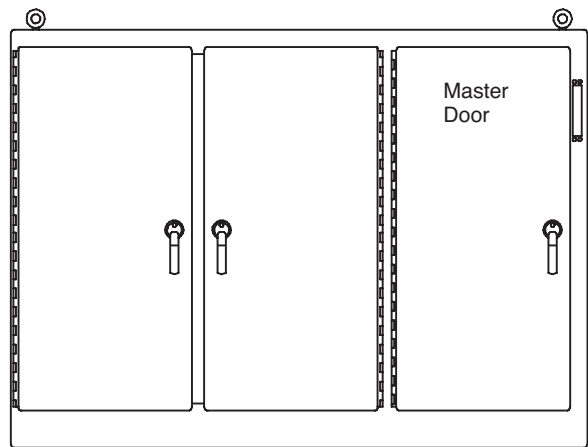

INSTALLATION STEPS

Step 1 – Install handle return spring (furnished with Square "D" operating handle) through hole provided in mounting plate (item 1) as shown. The long hooked end of spring goes through hole in mounting plate. The short hook on the other end will be attached to the rod later.

Step 2 – Install Mounting plate (item 1) (with spring in place) and plate gasket (item 2) on the inside of the enclosure, behind the rectangular opening provided. Secure in place with four screws (item 3).

Step 3 – Discard the Square "D" stiffener bracket which is normally installed inside the enclosure flange.

Step 4 – Assemble the Square "D" operating handle to the mounting plate which was installed in the enclosure in step 1. Omit cap screw and lockwasher which fits into bottom hole of operating handle.

Step 5 – Install the slide arm (item 4) over the projecting part of the handle assembly (on Square "D" operating handle) with notch toward door opening, as shown. Place the smaller diameter end of the shoulder collar (item 5) through the oval slot in the slide arm. Install long cap screw (item 6) with lockwasher (item 7) through shoulder collar into the bottom mounting hole of the Square "D" operating handle and tighten. The slide arm and interlock arm should move up and down smoothly. Install locking lever extension (Square "D" part) per Square "D" instructions.

Step 6 – Attach the bottom of the slide arm (item 4) to the offset arm of the lock release mechanism. Use two flat washers (item 8), two lockwashers (item 9), and two hex nuts (item 10). Do not tighten until parts are adjusted. (see step 7B)

Step 7 – The handle safety lock release mechanism is adjustable in two places.

(A) Check the adjustment of the factory installed roller bracket. The door latch should hit against the latch stop portion of the roller bracket when the door is closed and latched. Adjust up or down if necessary. The attached mechanism will then provide the necessary up-down motion required to operate the release mechanism.

(B) Adjust the length of the slide arm assembly. With proper adjustment of the slide arm, the safety lock (on Square "D" handle operator) should release just before the master door is fully latched. Lengthen slide arm if safety lock releases too soon. Shorten slide arm if safety lock releases too late.

Step 8 – Attach the door catch (item 11), provided by Hoffman, to the tapped spacer on the door using the bottom set of mounting holes. Use two screws (item 12) and lockwashers (item 13). The door catch prevents the door from being opened when the switch is in the "ON" position. The door catch may be easily bent up or down to hook properly on the locking lever extension of the Square "D" handle operator.

Step 9 – Drill and tap holes in panel as shown in diagram and table. See Square "D" instructions for locating holes for fuse clips.

Step 10 – Mount switch or circuit breaker using Square "D" instructions and parts. Square "D" operating rod (and stiffener rod, if used) must be cut off per Square "D" instructions. See table 2 for depth dimensions used to determine length of rods.

For One Through Six Door Free-Standing Enclosure with Disconnect on Right Flange

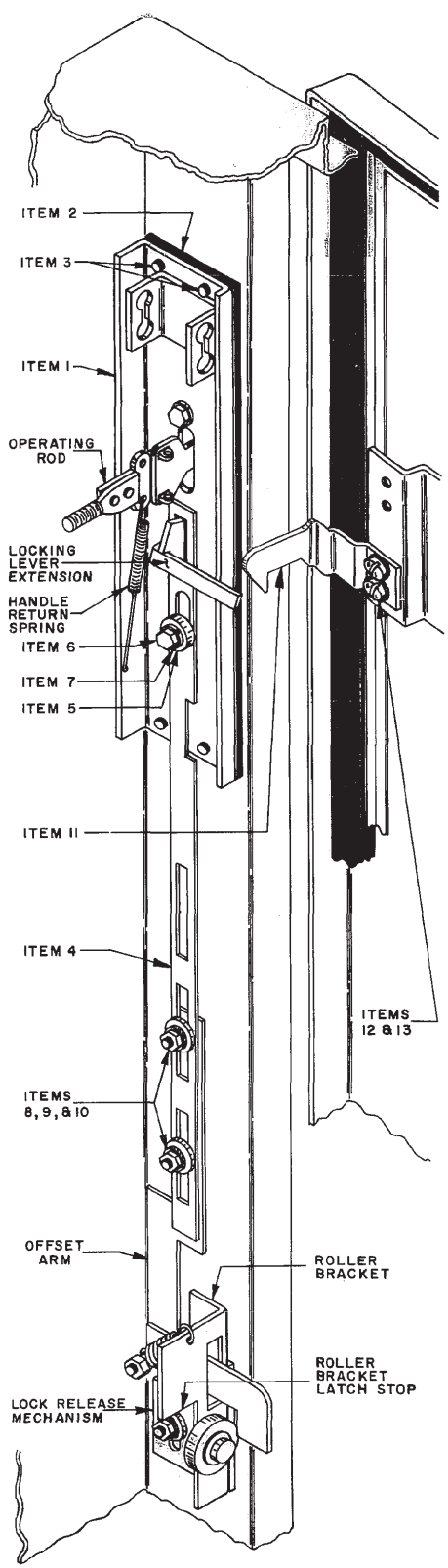

* Parts of lock release mechanism

For One Through Six Door Free-Standing Enclosures with Disconnect on Right Flange

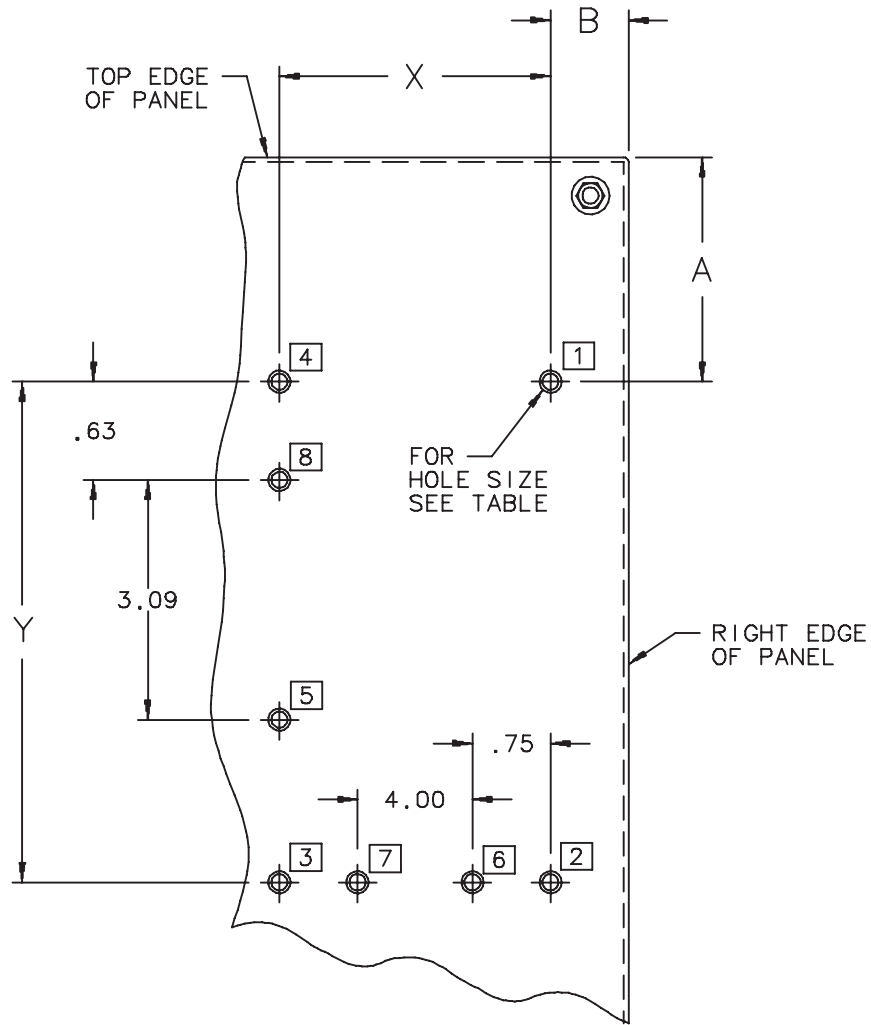

For One Through Six Door Free-Standing Enclosures With Disconnect on Right Flange

TABLE 1									
SQUARE "D" OPERATING MECHANISM	No. of Holes	Mtg. Hole Position	Mtg. Hole Size	Enclosure Height			B	X	Y
				72.12	84.12	90.12			
				A	A	A			
TCN, TCF	4	1,4,6,7	10-24	6.81	12.81	15.81	.50	5.50	4.50
TDN, TDF	4	1,4,6,7	10-24	6.81	12.81	15.81	.50	5.50	4.50
TEN, TEF	4	1,4,6,7	10-24	6.81	12.81	15.81	.50	5.50	4.50
TC	4	1,2,5,8	10-24	6.63	12.63	15.63	.50	5.13	6.50
TD	4	1,2,4,7	10-24	6.81	12.81	15.81	.59	5.19	5.25
TE	4	1,2,3,4	1/4-20	5.19	11.19	14.19	1.97	5.50	6.50
TF	4	1,2,3,4	5/16-18	4.56	10.56	13.56	1.44	9.44	8.00
RG1	4	1,2,3,4	8-32	6.81	12.81	15.81	1.59	1.18	3.94
RN1	4	1,2,3,4	8-32	7.34	13.34	16.34	1.50	1.50	5.13
RP1	4	1,2,3,4	10-24	7.34	13.34	16.34	1.69	1.50	7.13
RR-1	4	1,2,3,4	1/4-20	-----	12.69	15.69	.31	6.63	6.56
	4	1,2,3,4	.375 Dia.	-----	11.31	14.31	2.63	2.00	9.25
RT-1 For MAL, MHL	4	1,2,3,4	1/4-20	-----	10.56	13.56	.34	9.69	10.69
	4	1,2,3,4	.500 Dia.	-----	10.56	13.56	3.68	3.00	10.69
RR-1 For MEL	4	1,2,3,4	1/4-20	-----	10.56	13.56	.34	9.69	10.69
	4	1,2,3,4	.500 Dia.	-----	10.56	13.56	3.68	3.00	11.44

TABLE 2		
Hoffman Disconnect Enclosure Description	Enclosure Depth C	Square "D" D (1)
One and Two Door Free-Standing Disconnect on Right Flange	18.13	16.63
	20.13	18.63
	24.13	22.63 (2)
Three, Four, Five, and Six Door Free-Standing Disconnect on Right Flange	18.13	15.63
	24.13	21.63 (2)
One and Two Door Modular Free-Standing Disconnect on Right Flange	18.13	15.63
	24.13	21.63 (2)

1) This dimension is used to determine the length to cut off Square "D" operating rods. Use .125 for "T" dimension. See Square "D" instructions.

2) This dimension is greater than the depth range of standard Square "D" operating / stiffener rods. A six inch high platform is provided with this enclosure to reduce the depth for disconnect mounting. The platform can be eliminated if Square "D" 9422-R2 long operating rod(s) are used. Some devices require two operating rods.

INTRODUCTION

This installation instruction is for Square "D" Bulletin 9422 (variable depth) mechanisms. These mechanisms are for disconnect switches and circuit breakers mounted in Hoffman two door, floor-mounted enclosures with the disconnect on the centerpost.

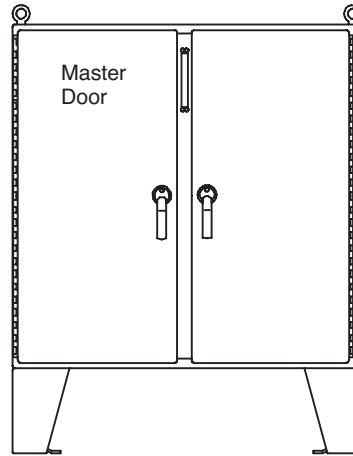

INSTALLATION STEPS

Step 1 – Install handle return spring (furnished with Square "D" operating handle) through hole provided in mounting plate (item 1) as shown. The long hooked end of spring goes through hole in mounting plate. The short hook on the other end will be attached to the rod later.

Step 2 – Install Mounting plate (item 1) (with spring in place) and plate gasket (item 2) on the inside of the enclosure, behind the rectangular opening provided in the centerpost. Secure in place with four screws (item 3).

Step 3 – Discard the Square "D" stiffener bracket which is normally installed inside the enclosure flange behind the operating handle.

Step 4 – Assemble the Square "D" operating handle to the mounting plate which was installed in the enclosure in step 1. Omit cap screw and lockwasher which fits into bottom hole of operating handle.

Step 5 – Cut 2 1/2" off bottom end of slide arm (item 4). (bottom end has rectangular holes only)

Step 6 – Install the slide arm (item 4) over the projecting part of the handle assembly (on Square "D" operating handle) with notch toward door opening, as shown. Place the smaller diameter end of the shoulder collar (item 5) through the oval slot in the slide arm. Install long cap screw (item 6) with lockwasher (item 7) through shoulder collar into the bottom mounting hole of the Square "D" operating handle and tighten. The slide arm and interlock arm should move up and down smoothly. Install locking lever extension (Square "D" part) per Square "D" instructions.

Step 7 – Attach the bottom of the slide arm (item 4) to the offset arm of the lock release mechanism. Use two flat washers (item 8), two lockwashers (item 9), and two hex nuts (item 10). Do not tighten until parts are adjusted.

Step 8 – Adjust the length of the slide arm assembly. With proper adjustment of the slide arm, the safety lock (on Square "D" handle operator) should release just before the master door is fully latched. Lengthen slide arm if safety lock releases too soon. Shorten slide arm if safety lock releases too late.

Step 9 – Attach the door catch (item 11), provided by Hoffman, to the tapped spacer on the door using the bottom set of mounting holes. Use two screws (item 12) and lockwashers (item 13). The door catch prevents the door from being opened when the switch is in the "ON" position. The door catch may be easily bent up or down to hook properly on the locking lever extension of the Square "D" handle operator.

Step 10 – Drill and tap holes in panel as shown in diagram and table. See Square "D" instructions for locating holes for fuse clips.

Step 11 – Mount switch or circuit breaker using Square "D" instructions and parts. Square "D" operating rod (and stiffener rod, if used) must be cut off per Square "D" instructions. See table 2 for depth dimensions used to determine length of rods.

*** NOTE: Optional channel/flange support kit, Square "D" class 9422 type C-1, is recommended when installing type TC, TD, RGI, RPI, RNI mechanisms in 72 1/8" high enclosures.**

For Floor-Mounted, Two Door Enclosure With Disconnect on Centerpost.

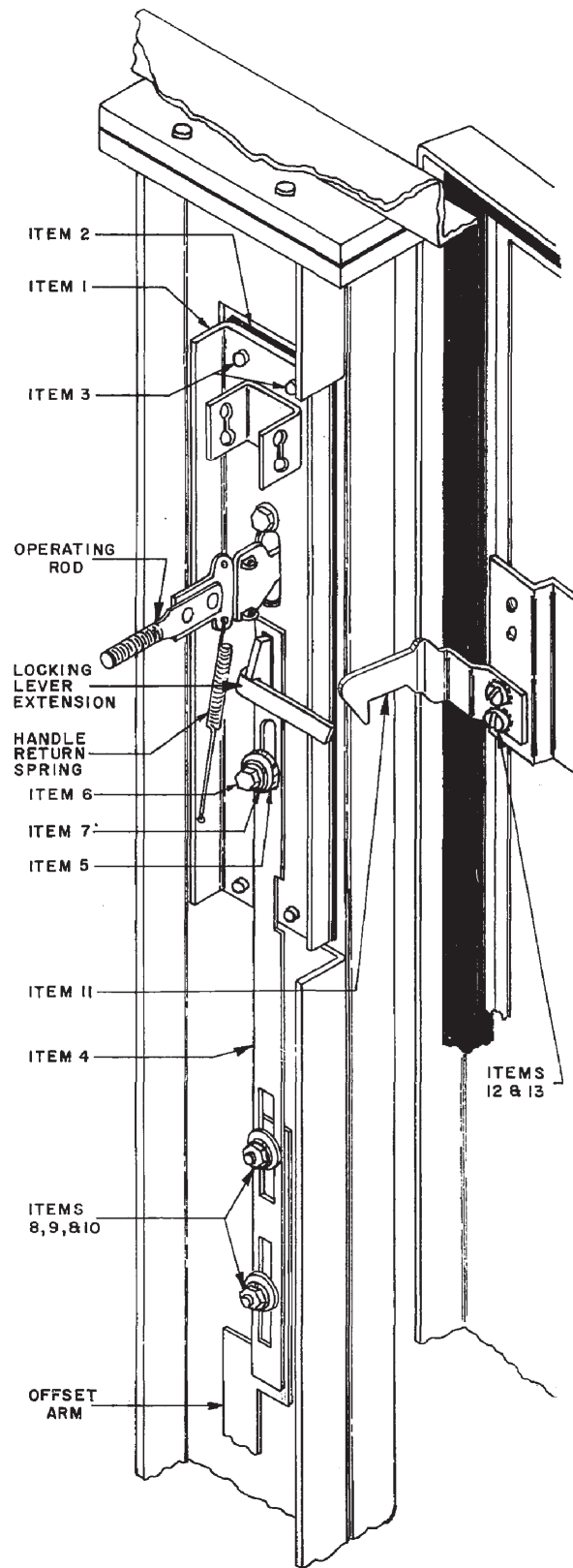

For Floor-Mounted, Two Door Enclosure With Disconnect on Centerpost.

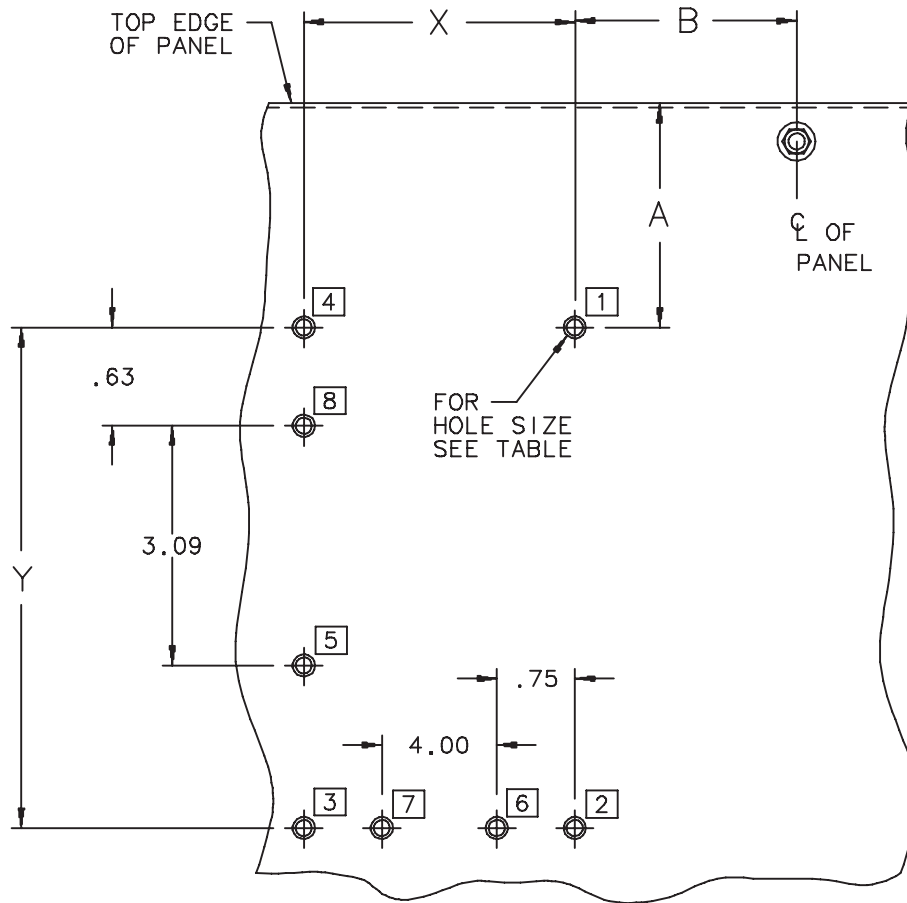

For Floor-Mounted, Two Door Enclosure With Disconnect on Centerpost

TABLE 1								
SQUARE "D" OPERATING MECHANISM	No. of Holes	Mtg. Hole Position	Mtg. Hole Size	Enclosure Height		B	X	Y
				60.12	72.12			
				A	A			
TCN, TCF	4	1,4,6,7	10-24	4.81	10.81	1.69	5.50	4.50
TDN, TDF	4	1,4,6,7	10-24	4.81	10.81	1.69	5.50	4.50
TEN, TEF	4	1,4,6,7	10-24	4.81	10.81	1.69	5.50	4.50
TC	4	1,2,5,8	10-24	4.62	10.62	1.69	5.13	6.50
TD	4	1,2,4,7	10-24	4.81	10.81	1.78	5.19	5.25
TE	4	1,2,3,4	1/4-20	3.19	9.19	3.16	5.50	6.50
TF	4	1,2,3,4	5/16-18	2.56	8.56	2.63	9.44	8.00
RG1	4	1,2,3,4	8-32	4.81	10.81	2.78	1.18	3.94
RN1	4	1,2,3,4	8-32	5.34	11.34	2.69	1.50	5.13
RP1	4	1,2,3,4	10-24	5.34	11.34	2.88	1.50	7.13
RR-1	4	1,2,3,4	1/4-20	----	10.69	1.50	6.63	6.56
	4	1,2,3,4	.375 Dia.	----	9.31	3.81	2.00	9.25

TABLE 2		
Hoffman Disconnect Enclosure Description	Enclosure Depth C	Square "D" D (1)
Two Door, Floor-Mounted Disconnect on Right Flange	12.13	10.63
	18.13	16.63
	24.13	22.63 (2)

1) This dimension is used to determine the length to cut off Square "D" operating rods. Use .125 for "T" dimension. See Square "D" instructions.

2) This dimension is greater than the depth range of standard Square "D" operating / stiffener rods. A six inch high platform is provided with this enclosure to reduce the depth for disconnect mounting. The platform can be eliminated if Square "D" 9422-R2 long operating rod(s) are used. Some devices require two operating rods.

INTRODUCTION

This installation instruction is for Square "D" Bulletin 9422 (flexible cable) mechanisms. These mechanisms are for disconnect switches and circuit breakers mounted in Hoffman disconnect enclosures.

Two door enclosure with disconnect on right flange



Two door enclosure with disconnect on centerpost

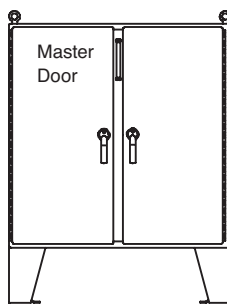

One through six door enclosure with disconnect on right flange

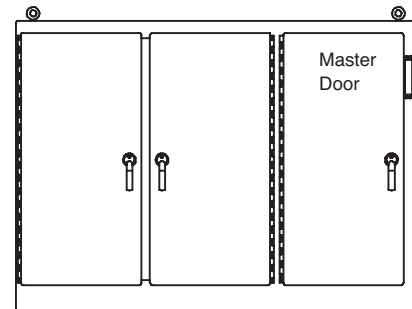

INSTALLATION STEPS

Step 1 – Install mounting plate (item 15) and plate gasket (item 2) on the inside of the enclosure, behind the rectangular opening provided. Secure in place with four screws (item 3).

Step 2 – Discard the Square "D" stiffener bracket which is normally installed inside the enclosure flange, behind the operating handle.

Step 3 – Assemble the Square "D" operating handle and cable handle mechanism to the mounting plate which was installed in the enclosure in step 1. Omit cap screw and lockwasher which fits into bottom hole of Square "D" operating handle.

Step 4 – Modify slide arm (item 4) only if it is being installed in an enclosure with disconnect on centerpost. (cut 2.5 inches off the bottom end of slide arm. Bottom end has rectangular holes only)

Step 5 – Install the slide arm (item 4) over the projecting part of the handle assembly (on Square "D" operating handle) with notch toward door opening, as shown. Place the smaller diameter end of the shoulder collar (item 5) through the oval slot in the slide arm. Install long cap screw (item 6) with lockwasher (item 7) through shoulder collar into the bottom mounting hole of the Square "D" operating handle and tighten. The slide arm and interlock arm should move up and down smoothly. Install locking lever extension (Square "D" part) per Square "D" instructions.

Step 6 – Attach the bottom of the slide arm (item 4) to the offset arm of the lock release mechanism. Use two flat washers (item 8), two lockwashers (item 9), and two hex nuts (item 10). Do not tighten until parts are adjusted. (see step 7B)

Step 7 – The handle safety lock release mechanism is adjustable.

(A) Check the adjustment of the factory installed roller bracket on enclosures with disconnect on right flange. The door latch should hit against the latch stop portion of the roller bracket when the door is closed and latched. Adjust up or down if necessary. The attached mechanism will then provide the necessary up-down motion required to operate the release mechanism.

(B) Adjust the length of the slide arm assembly. With proper adjustment of the slide arm, the safety lock (on Square "D" handle operator) should release just before the master door is fully latched. Lengthen slide arm if safety lock releases too soon. Shorten slide arm if safety lock releases too late.

Step 8 – Attach the door catch (item 11), provided by Hoffman, to the tapped spacer on the door using the bottom set of mounting holes. Use two screws (item 12) and lockwashers (item 13). The door catch prevents the door from being opened when the switch is in the "ON" position. The door catch may be easily bent up or down to hook properly on the locking lever extension of the Square "D" handle operator.

Step 9 – Drill and tap holes in panel as shown in diagram and table. See Square "D" instructions for locating holes.

Step 10 – Mount switch or circuit breaker using Square "D" instructions and parts.

For Floor-mounted, Two Door Enclosures With Disconnect on Right Flange
For Floor-mounted, Two Door Enclosures With Disconnect on Centerpost
For One Through Six Door, Free-Standing Enclosures With Disconnect on Right Flange

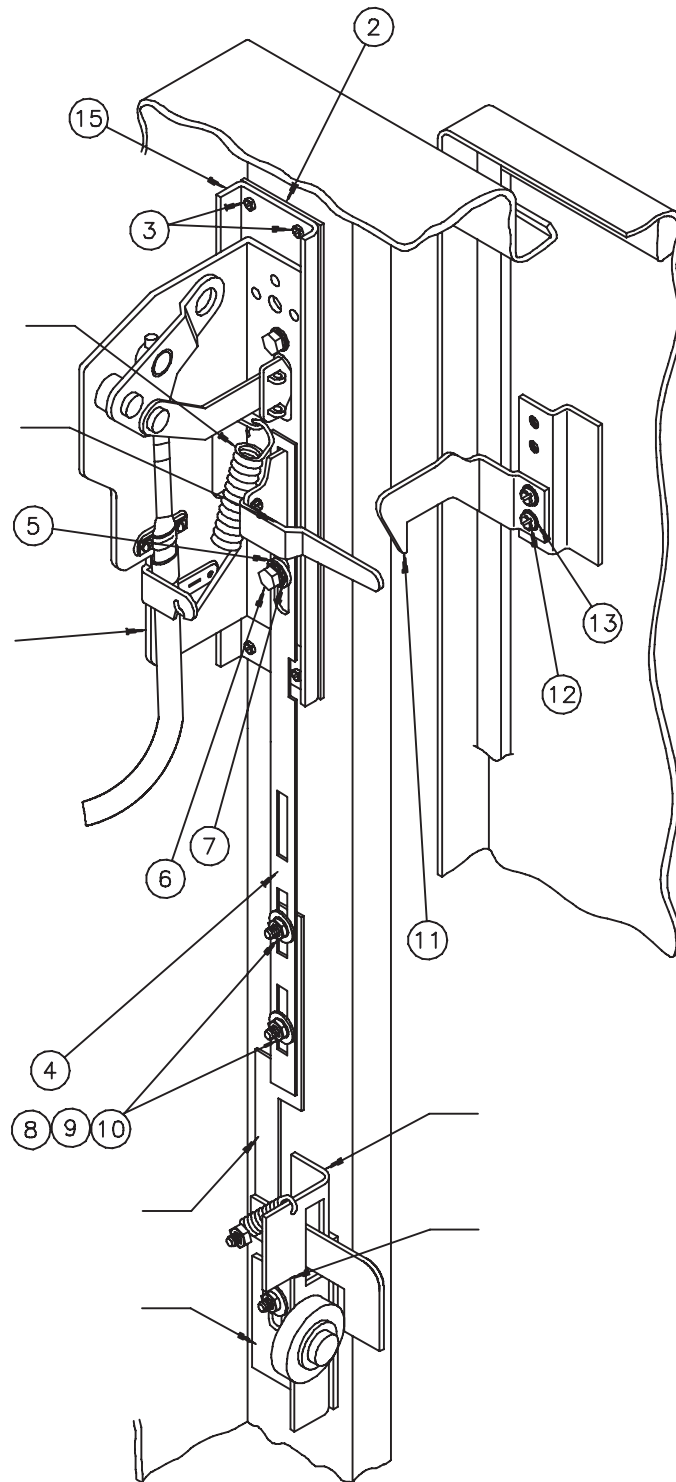

* Parts of lock release mechanism on enclosure with disconnect on right flange

For Floor-mounted, Two Door Enclosures With Disconnect on Right Flange
 For One Through Six Door, Free-Standing Enclosures With Disconnect on Right Flange

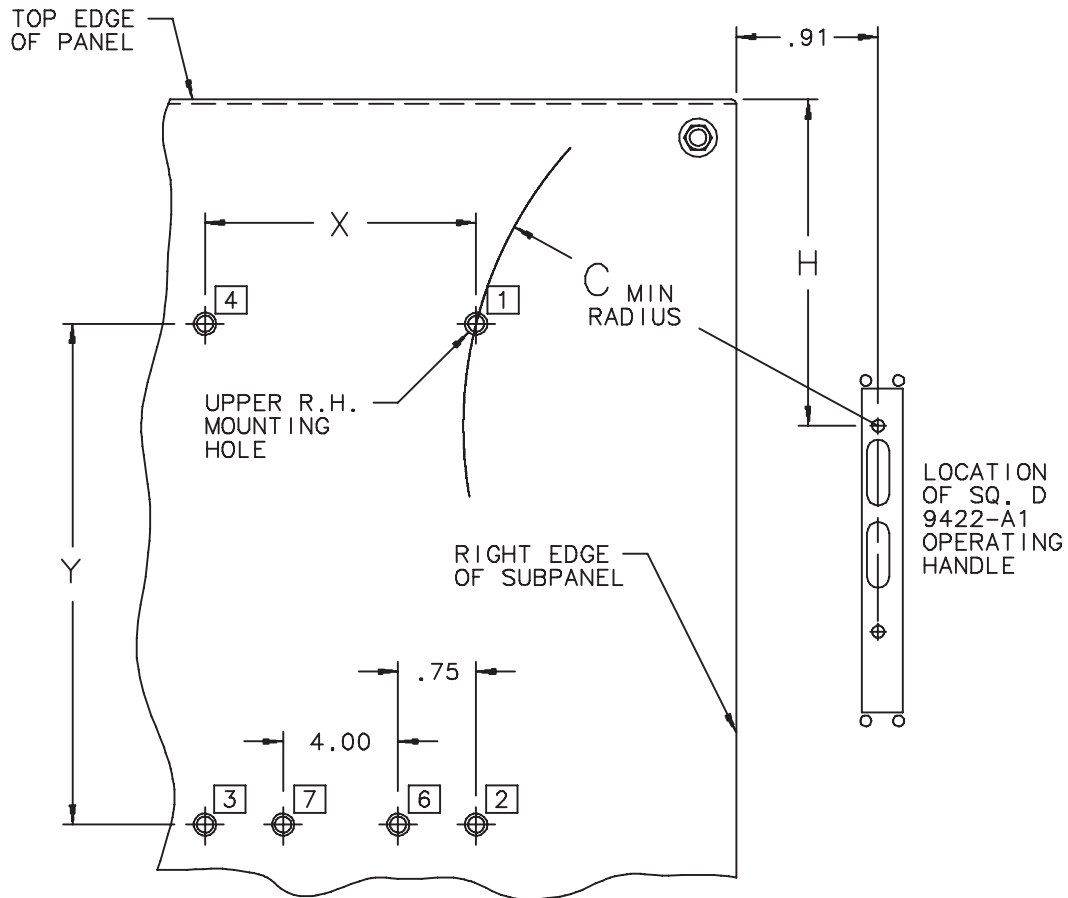

For Floor-mounted, Two Door Enclosures With Disconnect on Centerpost

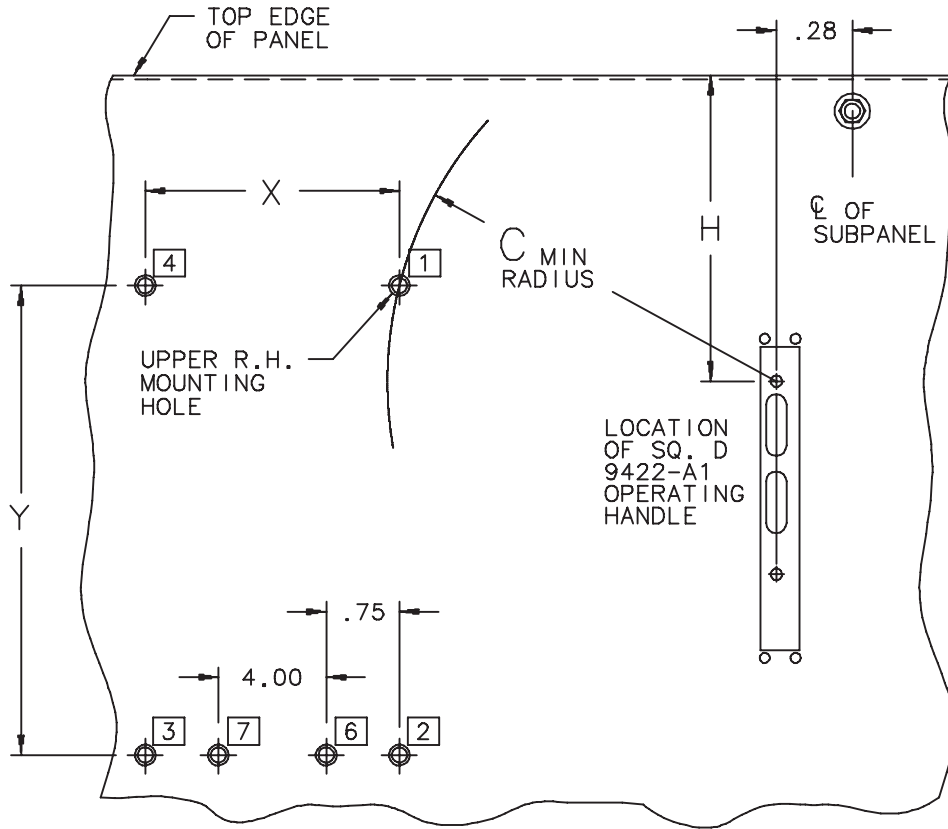

For Floor-mounted, Two Door Enclosures With Disconnect on Right Flange
 For Floor-mounted, Two Door Enclosures With Disconnect on Centerpost
 For One Through Six Door, Free-Standing Enclosures With Disconnect on Right Flange

Sub-Panel Drilling							
CABLE MECHANISM	DISCONNECT MECHANISM	No. of Holes	Hole Position	Hole Size	X	Y	Cmin*
CFT	TCN, TCF	4	1,4,6,7	10-24	5.50	4.50	1.00
	TDN, TDF	4	1,4,6,7	10-24	5.50	4.50	1.00
	TEN, TEF	4	1,4,6,7	10-24	5.50	4.50	1.00
CGJ	GJL	4	1,2,3,4	8-32	1.18	3.94	2.50
CFA	FAL, FHL	4	1,2,3,4	8-32	1.50	5.13	3.75
CKA	KAL, KHL	4	1,2,3,4	10-24	1.50	7.13	3.75
CLA**	LAL, LHL	4	1,2,3,4	1/4-20	6.63	6.56	2.25
		4	1,2,3,4	.375 Dia.	2.00	9.25	-----

* See Square "D" instructions for range of "C" dimension which vary for 36", 60" and 120" cable lengths.

** See Square "D" instructions for relationship between 1/4-20 and .375 diameter holes for LA circuit break.

Location of Disconnect Operating Handle		
Hoffman Disconnect Enclosure Description	Enclosure Height	H
Two Door Floor-Mounted Disconnect on Right Flange	60.13	5.81
	72.13	11.81
Two Door Floor-Mounted Disconnect on Centerpost	60.13	5.81
	72.13	11.81
One Through Six Door Modular Free-Standing Disconnect on Right Flange	72.13	7.81
	84.13	13.81
	90.13	16.81
One and Two Door Modular Free-Standing Disconnect on Right Flange	84.13	13.81
	90.13	16.81



HOFFMAN